

HUALI BATTERY CO.LTD

30H3A4H Ni-MH BUTTON CELL

TECHNICAL DATA

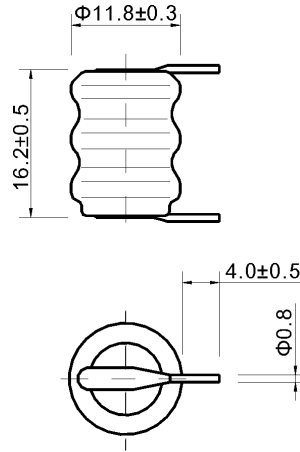

Model	Voltage	Capacity	Recommended Trickle Charge Current	Nominal Charge Current	Normal Charging Time	Nominal Discharge Current	Weight
30H3A4H	3.6V	40mAh	1.2~2mA	4mA	14~16h	8mA	5.8g

TECHNICAL CHARACTERISTICS

TYPICAL CHARGE CURVE (4mA)

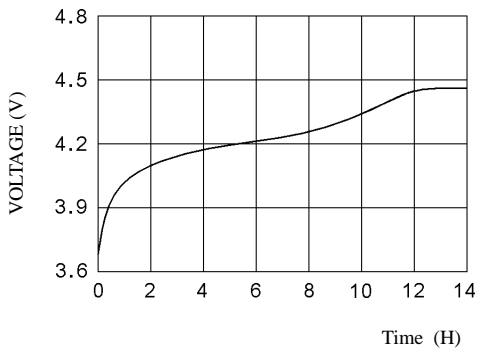

TYPICAL DISCHARGE CURVE (8mA)

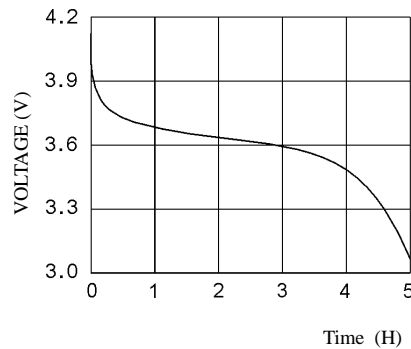

CYCLE LIFE CURVE

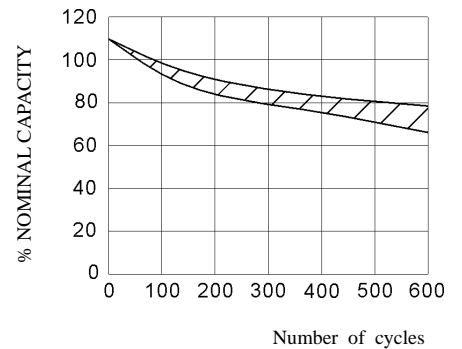

TYPICAL CHARGE CURVE AT VARIOUS CURRENTS

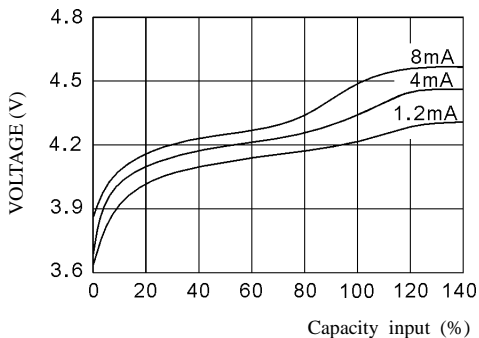

DISCHARGE CURVE AT VARIOUS TEMPERATURES (8mA)

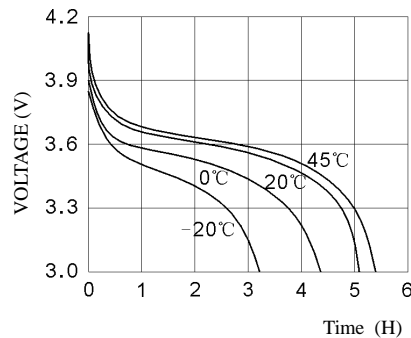

SELF DISCHARGE RATE AT VARIOUS TEMPERATURES

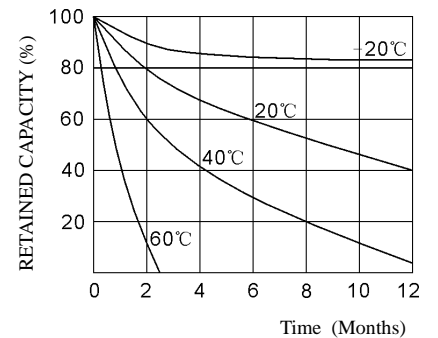

TECHNICAL INFORMATION

1. APPLICATION

This specification applies to the Ni-MH batteries

Model : 30H3A4H

2. CELL AND TYPE

2.1 Cell : Sealed Ni-MH Button Cell

2.2 Type : Button type

2.3 Size type : 3.6V

3. RATINGS

3.1 Nominal voltage : 3.6V

3.2 Nominal capacity : 40mAh

3.3 Typical weight : 5.8g

3.4 Standard charge : 4mA × 14hours

3.5 Rapid charge : 8mA × 6hours

Trickle current : 1.2mA

3.6 Discharge cut-off voltage: 3.0V

3.7 Temperature range for operation (Humidity: Max.85%)

Standard charge 0 ~ +45°C

Rapid charge +10 ~ +45°C

Trickle charge 0 ~ +45°C

Discharge -10 ~ +45°C

3.8 Temperature range for storage (Humidity: Max.85%)

Within 2 years -20 ~ +35°C

Within 6 months -20 ~ +45°C

Within a month -20 ~ +45°C

Within a week -20 ~ +55°C

4. ASSEMBLY & DIMENSIONS

Per attached drawing

5. PERFORMANCE

5.1 TEST CONDITIONS

The test is carried out with new batteries (within a month after delivery)

ambient conditions

Temperature: +25 ± 5°C

Humidity: 60 ± 20%

Note 1

Standard charge : 4mA × 14hours

Standard discharge : 8mA to 3.0V

5.2 TEST METHOD & PERFORMANCE

Test	Unit	Specification	Conditions	Remarks
Capacity	mAh	≥ 40	Standard Charge/discharge	Up to 3 cycles Are allowed
Open Circuit Voltage (OCV)	Voltage (V)	≥ 3.9	After 1 hour standard Charge	
Internal Impedance	m Ω /cell	≤ 2000	Upon fully charge (1KHz)	
High rate Discharge (20 mA)	Minute	≥ 60	Standard charge Before discharge	
Discharge Current	mA	20	Maximum continuous Discharge current	
Over charge		No leakage Not explosion	1.2mA charge one year	
Charge Retention	mAh	32	Standard charge; Storage: 28 days; Standard discharge	
Cycle Life	Cycle	≥ 400	IEC/CEI61951-2:2001. 4.4	
Leakage		No leakage nor Deformation	Fully charge at 4mA, Stand 14 days	

Note 2 IEC/CEI61951-2:2001. 4.4 cycle life

Cycle number	Charge	Stand in charged Condition	Discharge
1	4mA for 16h	None	10mA for 2h20min
2-48	10mA for 3h10min	None	10mA for 2h20min
49	10mA for 3h10min	None	10mA to 1.0V/cell
50	4mA for 16h	1h to 4h	8mA to 1.0V/cell

1. Before the endurance in cycles test, the cell shall be discharged at 8mA to a final voltage of 1.0V/cell.

2. The following endurance test shall then be carried out, in an ambient temperature of $20^{\circ}\text{C} \pm 5^{\circ}\text{C}$.

5.3 Humidity

The battery shall not leak during the 14 days which it is submitted to the condition of a temperature of $33 \pm 3^{\circ}\text{C}$ and a relative humidity of $80 \pm 5\%$.

6. OTHERS

6.1 We recommend you to set the cut-off voltage at 1.0V/cell.

6.2 If the cut-off voltage is above 1.1V/cell, the battery may be underutilized resulting insufficient use of the available capacity.

6.3 If it is below 1.0V/cell, the battery may have discharge or reverse charge to the cell.

7. PRECAUTION

The cells shall be delivered in charged condition. Before testing or using, the cell shall be discharged at $20 \pm 5^{\circ}\text{C}$ at a constant current of 8mA to a final voltage of 1.0V/cell.

7.1 Avoid throwing cells into a fire or attempting to disassemble them.

7.2 Avoid short circuiting the cells.

7.3 Avoid direct solidarity to cells.

7.4 Observe correct polarity when connecting.

7.5 Do not charge with more than our specified current.

7.6 Use cells only within the specified working temperature range.

7.7 Store cells in dry and cool place.